



WAVEFRONT PRECISION LONGBOW
**SCALABLE RESOLUTION
GOES FURTHER**



Unite Your Audience
The Martin Audio Experience





With the launch of the Wavefront Precision™ Series (WPM and WPC) the concept of scalable resolution was born — harnessing the research and technology behind Martin Audio's self-powered MLA® Series systems in a new line array format with external amplification. Delivering unmatched sound quality, coverage consistency and control in an affordable package, this uniquely flexible and upgradeable approach has been rapidly adopted by sound rental and installation companies worldwide to become the company's fastest ever selling line array series.

Wavefront Precision Longbow (WPL) now brings this high performance, control and flexibility to large-scale touring and install applications. Designed as a complete system with external iKON® multi-channel amplifiers, automated DISPLAY™ optimisation software and VU-NET™ control platform, WPL provides financial accessibility to the top echelons of touring and install sound — from prestigious stadium concert and outdoor festivals, to high-specification arena and House of Worship installations.

The complete system philosophy guarantees that WPL arrays perform predictably and effortlessly to their design maximum, as well as ensuring that they are compatible with other WPL systems throughout the world.



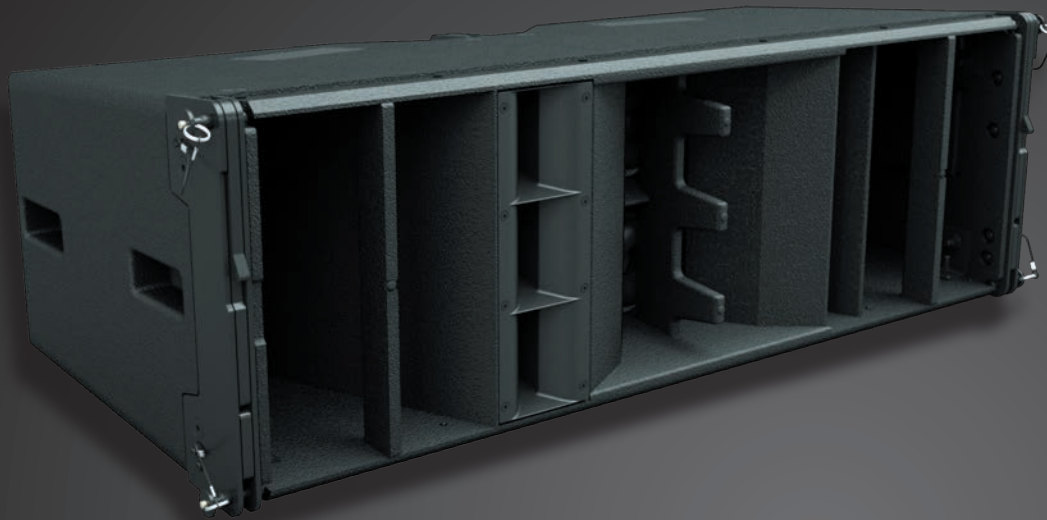

FEATURES

- High-performance large format line array
- All-horn, maximum-efficiency design
- Exceptional signature sonic performance
- Exemplary 90° horizontal constant directivity pattern control
- External, dedicated, multi-channel Class D amplification
- Scalable resolution for flexible optimisation of coverage, consistency and control
- Industry-leading DISPLAY software interacts with DSP for highly-accurate array optimisation
- Fast, integral 3-point rigging for up to 24 enclosures
- Compact and light weight design with discreet side handles for ease of handling

BENEFITS

- Consistent coverage achieved 'straight-out-of-the-box'
- DISPLAY intelligent software reduces set-up time and eliminates trial-and-error
- Improved audience coverage with reduced sound-spill

APPLICATIONS

- Touring sound reinforcement for festivals, stadiums and arenas
- Sports stadium and arena installations
- Concert hall and HoW installations

ALL-HORN ADVANTAGE



WPL is a full-scale line array which is capable of exceptionally high output for its modest size and weight. A three-way, bi-amped system, its very high output is achieved by utilising Martin Audio's trademark horn-loading technology across all frequency bands — increasing the acoustic output of the low frequency section, as well as the midrange and HF.

It incorporates 2 x 12" (300mm) drivers with Hybrid® horn/reflex loading, 2 x 6.5" (165mm) cone drivers on a midrange horn which covers the vocal frequency range from 300Hz to 4kHz, and 3 x 1" (25mm) exit HF drivers operating from 4kHz upwards. Each section features innovative horn-loading techniques and

refinements which raise the acoustic performance of WPL to a superior level — both in terms of output and smooth 90° horizontal coverage patterns of the mid and HF horns. Sonically, WPL's exemplary horizontal dispersion pattern translates to an incredibly consistent frequency response off-axis, with minimal variation from the on-axis response.

The maximum peak outputs of the LF, Mid and HF sections are 139dB, 140dB and 145dB per enclosure @1m and 6dB crest factor, respectively – ensuring that a WPL array will meet the most demanding requirements for throw and clarity in the largest venues and outdoor events.

MODERN PRACTICAL DESIGN

As well as delivering exceptional sonic performance, WPL is designed to meet the everyday practical challenges encountered by tour sound crews and installers. Its modest size and light weight - just 64kg (141lbs) - are born from detailed attention to all aspects of its physical design, and a range of accessories ensure that it is easy to transport and fast to deploy.

The WPL enclosure is constructed from plywood and finished as standard in a tour-ready heavy-duty Warnex finish (PU coated available as an option). Two side pocket handles on each side assist handling, while their discreet design is perfectly suited to installation. An integrated three-point rigging system assures efficient and safe construction of arrays of up to 24 enclosures. A rigid perforated steel grille protects the front of the enclosure.



SCALABLE RESOLUTION™ – FLEXIBLE OPTIMISATION OF COVERAGE, CONSISTENCY AND CONTROL

With unmatched line array performance inherent in the acoustic design of WPL, scalable resolution offers versatility in the way a WPL array is powered and optimised. The greater the number of individually driven enclosures, the more precisely DISPLAY can fine-tune the array's coverage, consistency and control within the venue. The advantages of higher resolution over a uniformly-driven line array are very significant — with front-to-rear frequency responses kept closely aligned and with greatly reduced output behind the array.

Bi-amped, with a passive mid/high crossover, a 12-enclosure array can be driven by either 3 x iK42 amplifiers (2-box resolution) or 6 x iK42 amplifiers (1-box resolution). With the number of amplifiers determined to suit the venue, the

application and the budget, the commercial advantages of scalable resolution are clear:

- Design systems to suit budget targets
- Dynamic deployment within a venue or site where the main PA is driven with more amplifier channels than may be necessary for delays
- Adaptable rental pricing based on event dynamics and clients' resources

For special case installations that require the ultimate resolution, it is possible to by-pass the internal passive crossover and control individual transducers independently. This maximum resolution case offers full MLA-type control, but with the external, ground-based amplification some installers prefer for large-scale fixed installations and stadiums.

Two Box Resolution Three iK42 Amplifiers

Bi-amp Cabinets
2 Cabinets in parallel
Total – 12 channels



One Box Resolution Six iK42 Amplifiers

Bi-amp Cabinets
Each Cabinet driven individually
Total – 24 channels

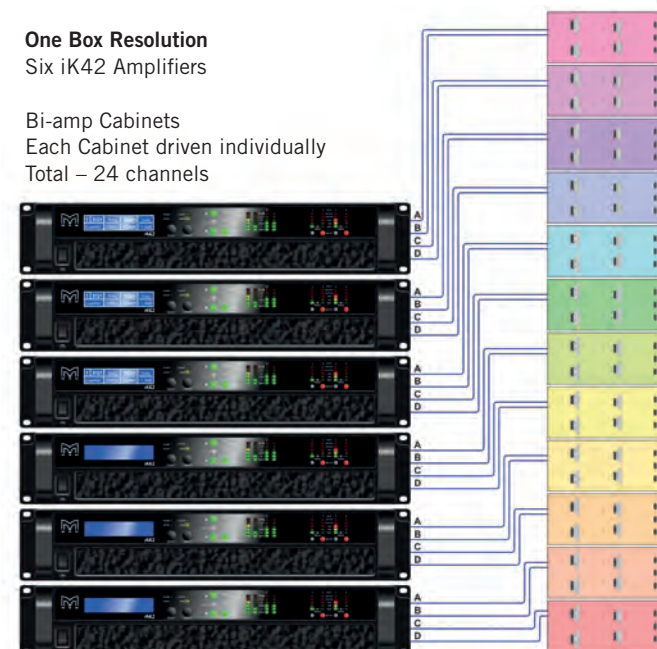

INCREASING RESOLUTION FOR IMPROVED CONSISTENCY,
CONTROL & COVERAGE

Starting with standard / uniform driven line array results:

1. Large variance in SPL between various points in venue
2. Uneven frequency response

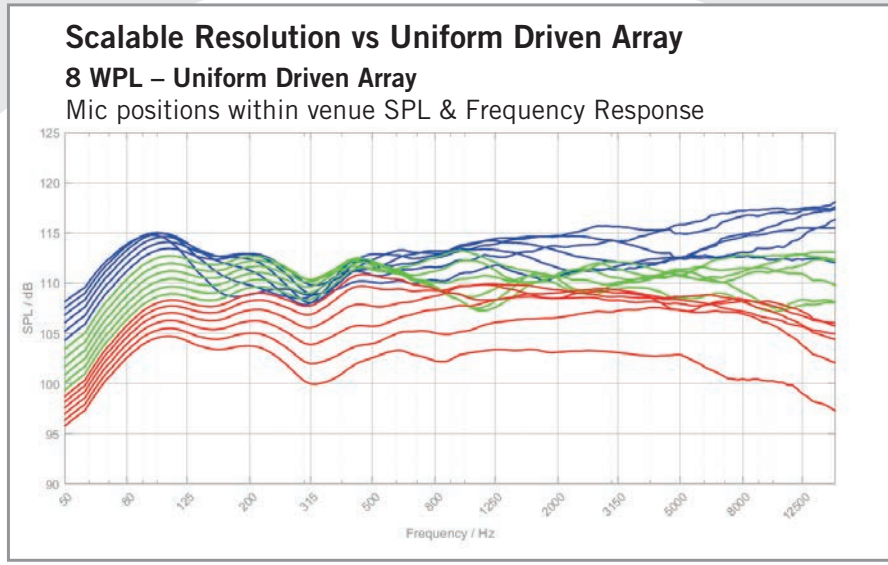

— Front Row
— Mix Position
— Back Row

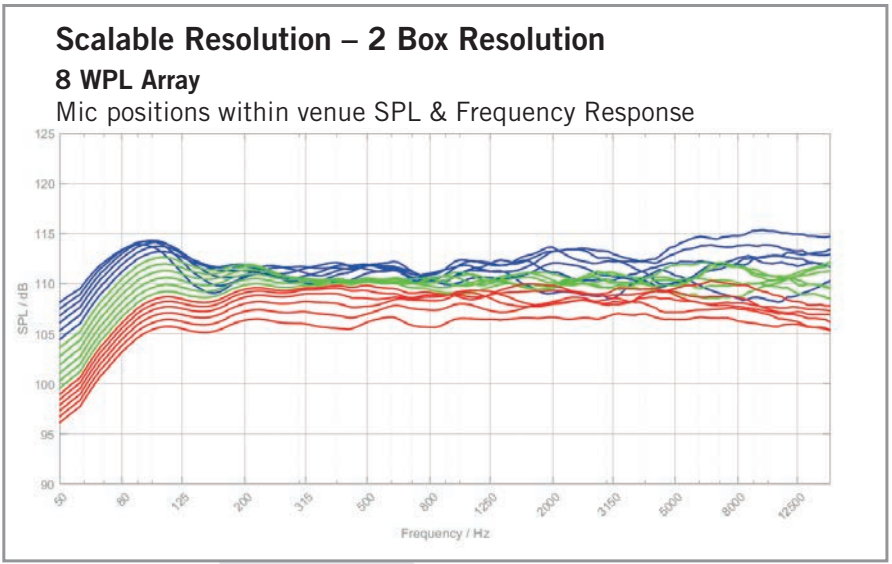

2 Box Resolution:

1. Increase in consistency in SPL measurements
2. Frequency response more consistent too

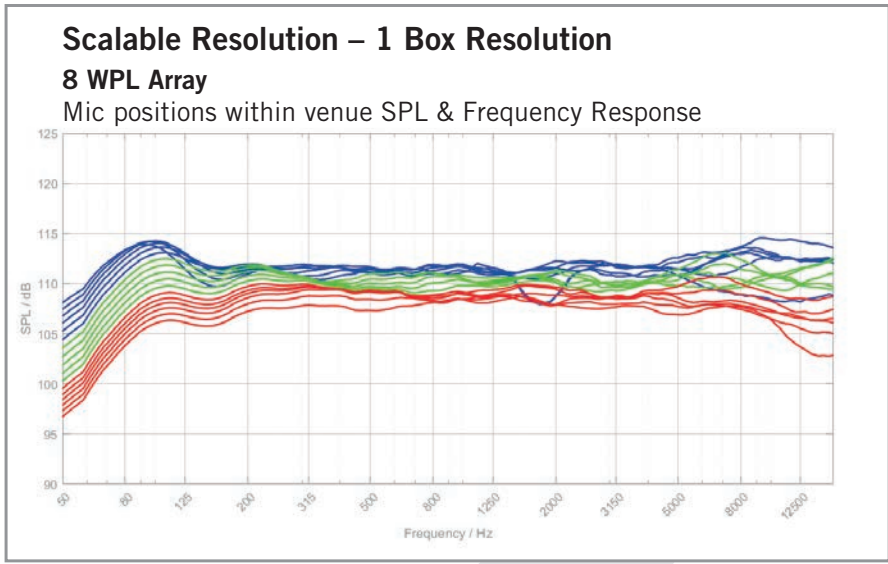

1 Box Resolution:

1. SPL measurements now increasingly even across the audience
2. Frequency response across audience is now very consistent

DISPLAY OPTIMISATION – ACCURATE RESULTS FROM SWITCH-ON

DISPLAY is an extremely powerful prediction and array configuration tool. Instead of using a standard geometric model, DISPLAY is based on an industry-leading acoustic model accurate to within $\pm 1\text{dB}$ of measured data, and delivers unrivalled coverage consistency over the audience — right from switch-on.

DISPLAY takes trial-and-error out of array deployment — generating highly-accurate SPL and frequency response predictions throughout the venue, as well as providing comprehensive rigging information, including mechanical safety analysis. DSP parameters calculated by DISPLAY are easily uploaded to the iKON amplifiers via Ethernet, using Martin Audio's VU-NET real-time control and monitoring software.

By reducing sound impacting non-audience areas, rear walls and ceilings, DISPLAY mitigates the detrimental influence of the venue acoustics — increasing clarity and intelligibility. DISPLAY's Hard Avoid® function can also be used to reduce sound-spill onto stages and rapidly reduce throw beyond a festival perimeter. Significantly, DISPLAY's ability to keep off-site sound within strict limits while maximising audience levels out-front can bring new life to previously unworkable outdoor events.

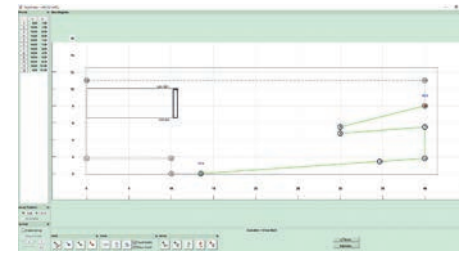

Step 1: Venue entry

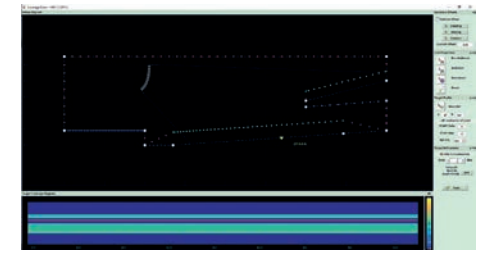

Step 2: Set coverage parameters

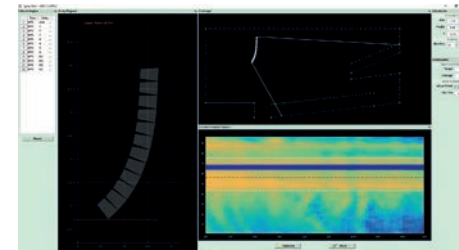

Step 3: Calculate splay angles

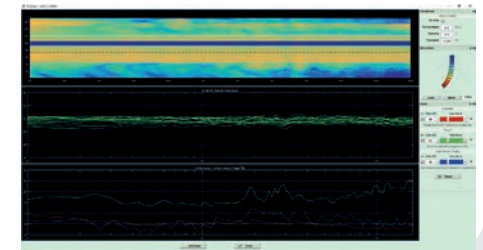

Step 4: Optimisation and upload



AMPLIFICATION, DSP AND NETWORKING

WPL is designed as a complete system with dedicated, high-performance iKON multi-channel Class D amplifiers. For 1-box and 2-box resolution, the iK42 4-channel amplifier delivers very high power outputs and features high-speed Ethernet communication for system control and monitoring via Martin Audio's VU-NET software, plus Dante™ digital audio networking. With the option to transmit digital audio over a single CAT5 cable, quality is maintained over long cable runs and integration with other devices in the sound system is straightforward.

For the ultimate resolution install case, where each mid and HF transducer is driven independently, a complement of iK42 4-channel and iK81 8-channel amplifiers power the bass section, each mid and HF driver individually.

Because the amplifiers are external to the loudspeaker enclosures, the resolution of the array can be increased as required by simply adding more amplifier channels to drive more array enclosures independently — increasing the level of control available to DISPLAY to fine-tune coverage and reduce room influence. External amplifiers also facilitate ease-of-servicing in fixed installations.

iK42/iK81 FEATURES

- Four/eight channels of Class D amplification
- Onboard DSP on all inputs and outputs
- FIR filtering on each output
- Switch mode, global voltage power supply
- 20,000 watts (iK42)/10,000 watts (iK81) total RMS output
- Intuitive front panel user interface
- Ethernet network for system operation and monitoring via VU-NET
- Analogue, AES3 and Dante™ digital network audio inputs
- Extensive protection and monitoring

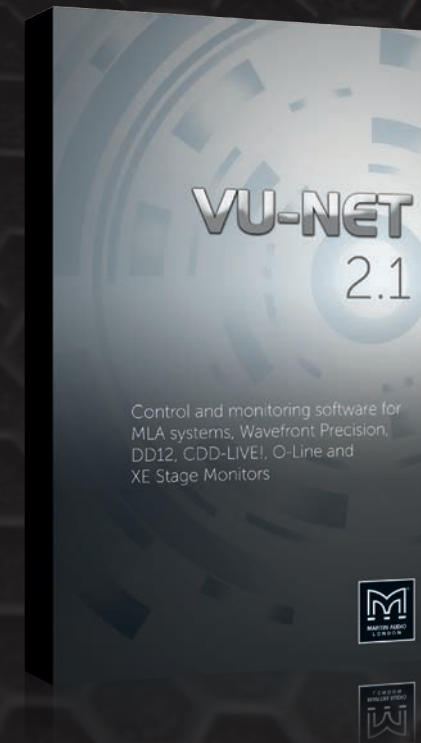

iKON

DUAL HYBRID® HORN LF SECTION – INCREASED EFFICIENCY AND OUTPUT

Hybrid technology combines the efficiency and impact of a bass horn with the low frequency extension of a bass-reflex enclosure. With a typical efficiency improvement of 4dB compared to direct radiator low-end designs of competitors, a WPL array has a noticeable advantage over direct radiator arrays when projecting maximum LF output over distance.

The LF section utilises 2 x 12" (305mm) drivers front-loaded by separate hyperbolic horns for maximum efficiency and rear-loaded by a reflex ported chamber. A differentially flared port reduces turbulence and air noise. Spacing the mouths of the twin horns as far apart as possible within the enclosure assists directivity control down to 150Hz — reducing bass mid-bass output at the sides and rear of the array. The drivers themselves are designed for very high excursion and feature 3" (75mm) voice coils, neodymium magnet structures and forced air cooling to reduce power compression.

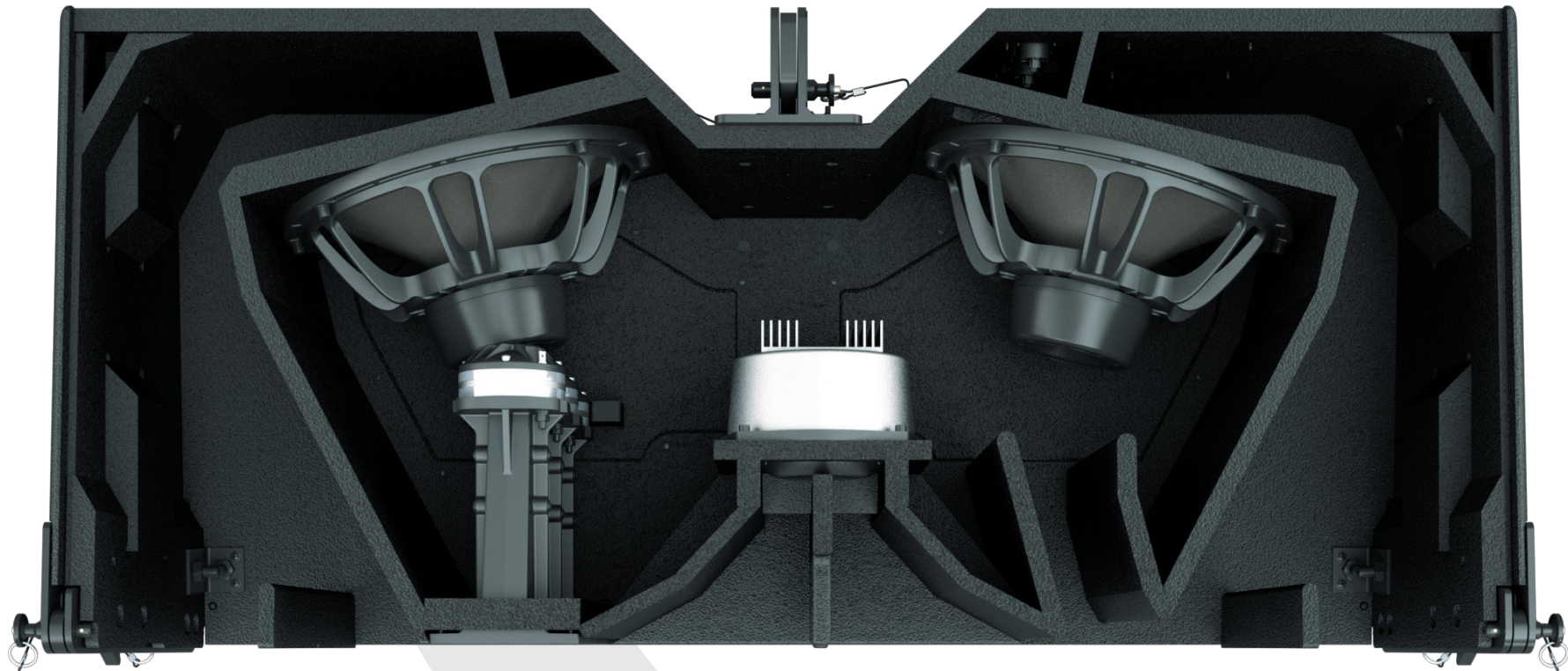

HORN-LOADED MIDRANGE – ENHANCED VOCAL CLARITY & CONSISTENCY

The patented mid-range section is central to the signature sound and superb horizontal pattern control of WPL. Compared to direct radiator midrange designs of competitors, the horn design of WPL mid has the advantages of both greater output and superior horizontal pattern control which does not vary significantly with frequency.

Featuring 2 x 6.5" (165mm) cone drivers with toroidal phase bungs and mounted on a 90° horizontal constant-directivity horn, the midrange section covers the range from 300Hz-4kHz. Crucially, operating over an entire decade means that the fundamental frequencies of the vocal range are reproduced by a single device and a single diaphragm material, thereby offering superior consistency and clarity against competitor designs that combine different device and diaphragm material.

Additionally, the low-compression ratio in the horn throat afforded by the patented toroidal phase bungs reduces distortion compared to high-compression horn designs and the HiBlade™ waveguide smooths and improves the horizontal directivity of the horn throughout its range. The technical refinements of the midrange horn contribute to the exceptionally powerful and smooth vocal performance of WPL.

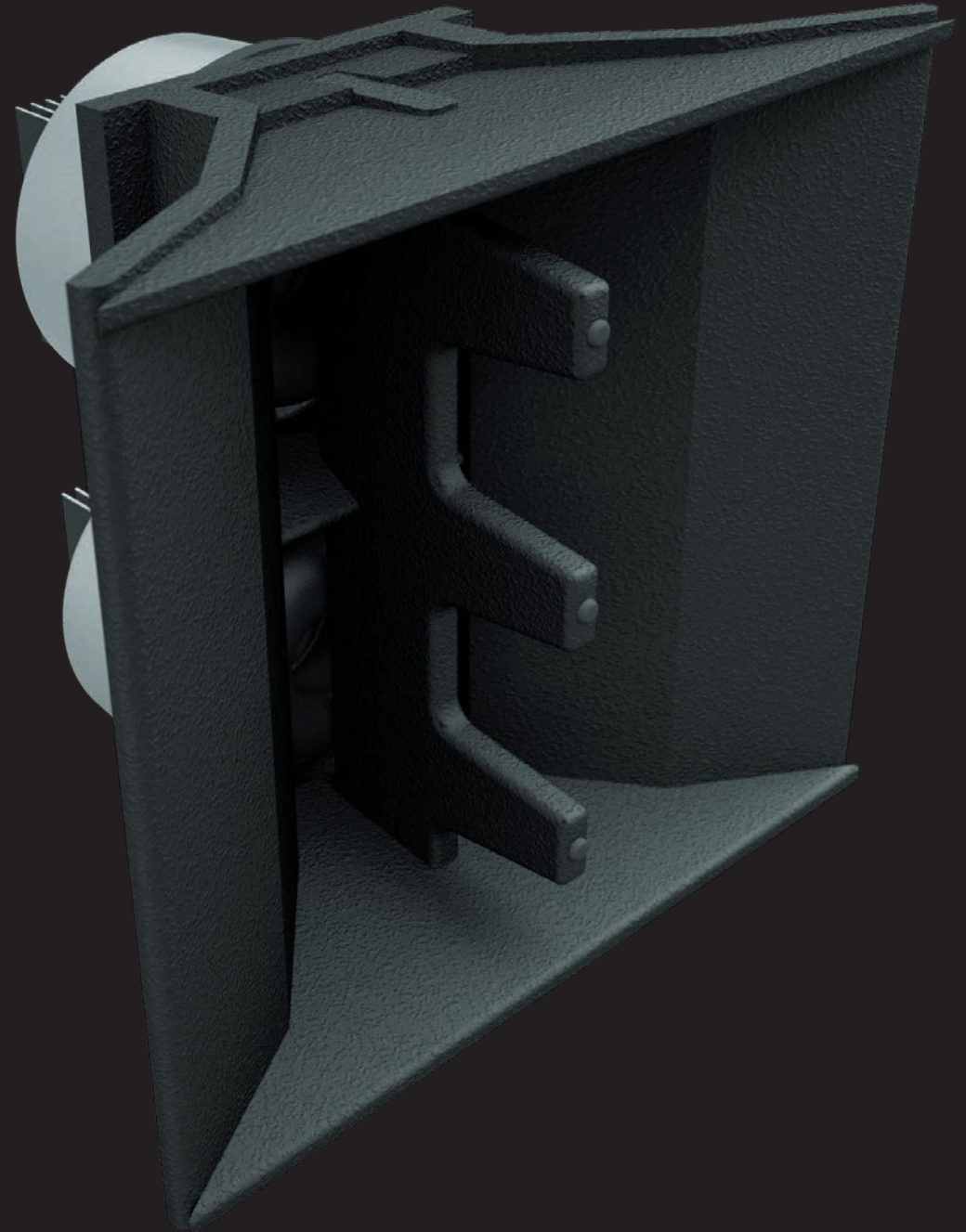

HIGH FREQUENCY SECTION – PRISTINE HIGH FREQUENCY SOUND

Operating from 4kHz upwards, the HF section of the WPL utilises 3 x 1" (25mm) exit neodymium compression drivers mounted on individual horns with true 90° horizontal constant directivity characteristics.

Competitors traditionally use large format compression drivers in line arrays which typically cross-over an octave lower, resulting in increased distortion and harsh sound just where the ear is at its most sensitive.

In contrast, the high 4kHz crossover point enabled by the midrange horn design, together with the use of smaller HF diaphragm drivers means that WPL delivers pristine high frequency sound with much lower distortion than traditional designs — with the added benefit of a more extended extreme top-end not achievable from large-format devices operating in the break-up region at the upper end of their range.

Patented kite-shaped 'wedges' in the throat of each horn flatten the curvature of the wavefront so that the HF section operates as a true line array.



FAST AND EASY RIGGING – DEPLOYMENT SPEED

Safety, simplicity and speed are essential aspects of a rigging system which the WPL three-point rigging system fully addresses. The rigging design allows for suspension of up to 24 enclosures, with DISPLAY software calculating the splay angles from 0°-7.5° needed to produce the desired vertical coverage. DISPLAY also determines the safe limits and tilt angle of an array and confirms compliance with specific safety standards, including BGV-C1, prior to deployment.

FRONT RIGGING POINTS

The front hinge points at the top of each WPL enclosure over-extend to ensure that there is plenty of ‘finger-room’ for riggers to pin enclosures together. As well safeguarding hands, this over-extension also gives useful latitude when connecting the lowermost box in an array to the uppermost box on a dolly which may not be on level ground, such as a festival site. As the hang is lowered, a second pin locks the hinge in place in its unextended position to minimise the gap between enclosures at the hinge point to just a few millimetres, ensuring vertical coverage consistency.

REAR RIGGING POINT

The rear rigging point sets the inter-cabinet splay angles determined by DISPLAY, and the design allows the angles to be easily set by a quick-release pin while enclosures are in their closed-up transport positions on the dolly. Once the uppermost enclosure on the dolly is attached to the array and the array is lifted, the dolly enclosures open up to the correct splay angles. A second pin locks each in place.





SXH218 HYBRID® SUB BASS – CHEST THUMPING EFFICIENCY



The SXH218 is a highly-powerful ground-stack subwoofer capable of producing 148dB peak output at 1m. Its Hybrid® horn/reflex loading combines the acoustic efficiency and impact of bass horn technology with the low frequency extension of a reflex design, enabling it to produce significantly higher output levels than a traditional reflex-loaded subwoofer. In most applications this means fewer subwoofers are required to achieve better results than standard reflex-loaded subwoofers. With an operating range of 32-150Hz + 3dB, it features dual long-excursion 18" (460mm)/4.5" (115mm) voice coil neodymium drivers, with water resistant cones and triple roll surrounds.

The enclosure is constructed from multi-laminate plywood and finished with a rugged polyurea coating. A rigid perforated steel grille protects the front of the enclosure, while interlocking skids protect the top and bottom surfaces and prevent movement when stacked.

SXHF218 FLOWN HYBRID® SUB BASS

The SXHF218 is a version of the SXH218 with flying hardware. It can be incorporated at the top of a WPL array, or more commonly flown as a separate array alongside. Like the ground-stack version, a combination of forward and rear-facing enclosures can be configured with specific directional properties.

The SXH218 can be powered by either a single channel of an iK42 4-channel amplifier, or a bridged pair if maximum output is required. DSP settings for each SXH218 are determined by DISPLAY™ and uploaded to the iK42 over Ethernet via the VU-NET™ real-time control and monitoring interface. A combination of forward and rear-facing enclosures can be configured by DISPLAY as a directional subwoofer array with specific directional properties, including cardioid.

ACCESSORIES – THE COMPLETE PACKAGE

TOURING FLYING FRAME AND OUTRIGGER

The WPL Touring Flying Frame is used for suspension of up to 24 enclosures with a two-point lift, or up to 10 enclosures with a single-point lift. With the addition of an outrigger, it also provides for ground stacking of WPL's up to six high. A simpler install flying frame is also available.

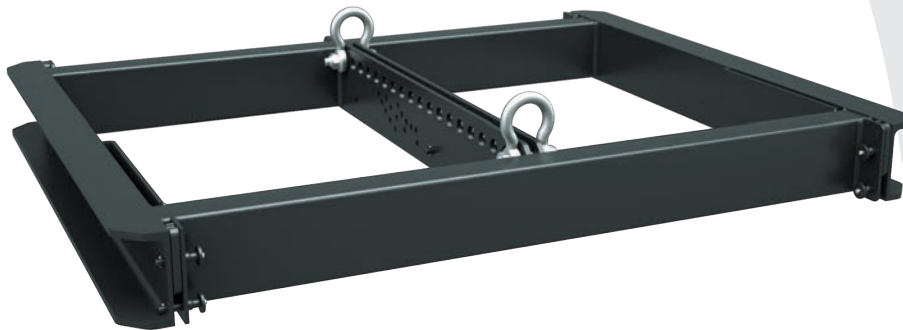

4-BOX DOLLY/CART

The dolly is a convenient, compact solution for transporting 4 WPL enclosures. Four dollies will fit length-wise in standard US and European trucks. The top of the dolly is load-bearing to allow stacking of other equipment within the height of the truck.



AMPLIFIER RACK

The 9U high amplifier rack for the WPL houses 3 iK42 4-channel Class D power amplifiers. This provides 12 channels of amplification to power a 12-enclosure array with 2-box resolution, while two amplifier racks will provide 24 channels of amplification to power a 12-enclosure array with 1-box resolution. Each amplifier rack is equipped with a 2U mains distro, 3 NL8 output connectors and a multiway connector that will power an array of 12 enclosures (2-box resolution) or 6 enclosures (1-box resolution) via a single multicore cable.

TECHNICAL SPECIFICATIONS

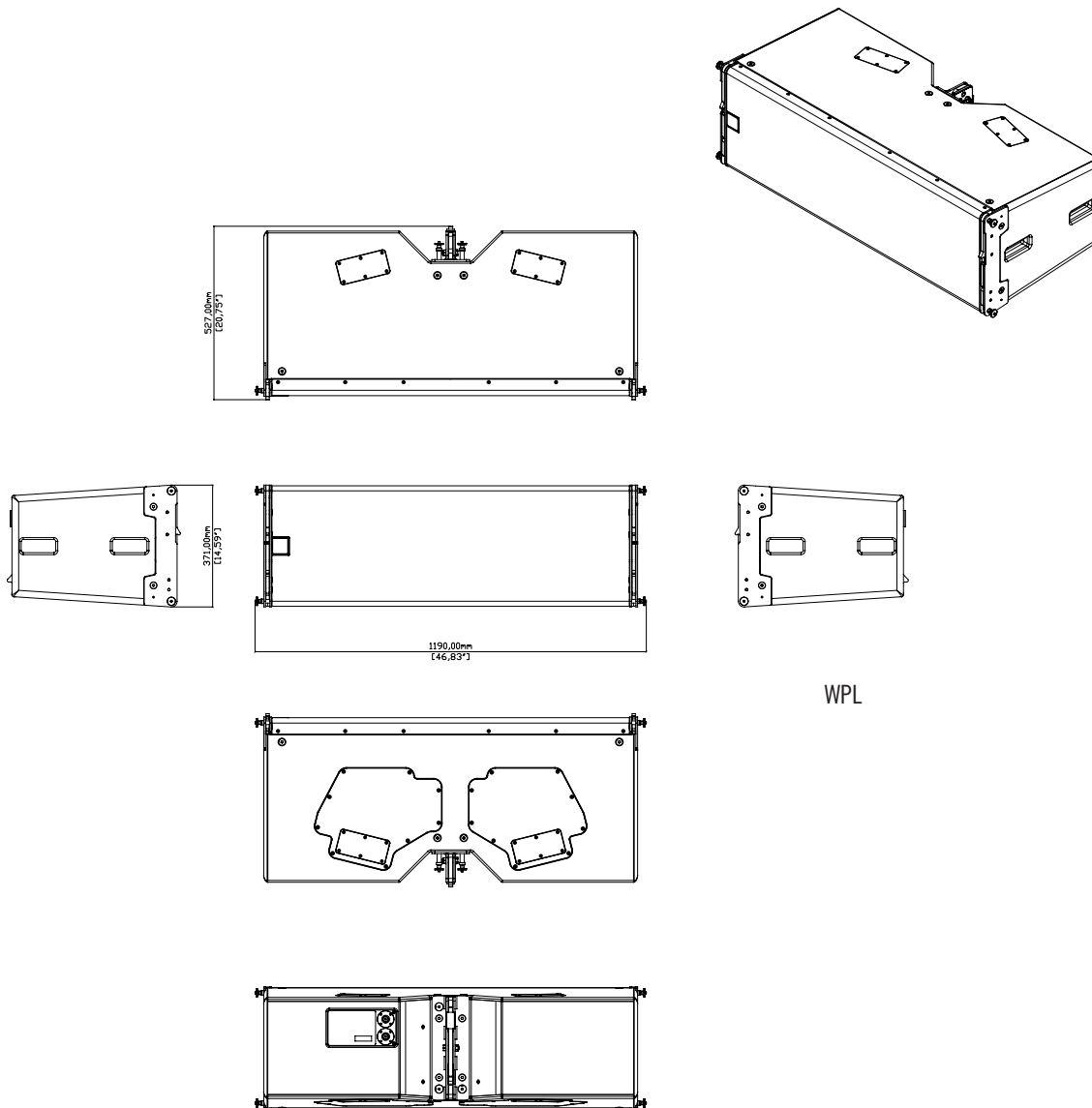

WPL

TYPE	Three-way, bi-amp line array element
FREQUENCY RESPONSE (5)	52Hz-18kHz \pm 3dB
DRIVERS	LF: 2 x 12" (300mm)/3" (75mm) voice coil, ultra-long excursion, neodymium magnet drivers, Hybrid® bass horn loaded MF: 2 x 6.5" (165mm)/2" (50mm) coil, neodymium magnet drivers, horn loaded HF: 3 x 1" (25mm) exit neodymium magnet compression drivers, horn loaded
SYSTEM AMPLIFIER	iKON iK42
SYSTEM RESOLUTION	1 or 2 enclosures per amplifier channel
MAXIMUM SPL (9)	LF: 139dB MF: 140dB HF: 145dB
NOMINAL IMPEDANCE	LF: 8 ohms, MF + HF: 8 ohms
DISPERSION	90° horizontal (-6dB), 120° horizontal (-10dB) 7.5° vertical
CROSSOVER	320Hz active, 4kHz internal passive
ENCLOSURE	Vertical trapezoid with 3.75° wall angle, multi-laminate birch and poplar-ply construction
FINISH	Black textured paint
PROTECTIVE GRILLE	Black HEX perforated steel
CONNECTORS	2 x NL4 type
PIN CONNECTIONS	LF: 1+/-1-, MF + HF: 2+/-2-
FITTINGS	3-point rigging system 4 x side pocket handles
FLOWN ARRAY MAXIMUM	24 enclosures in single array
DIMENSIONS (ex. pins)	(W) 1136mm x (H) 371mm x (D) 526mm (W) 44.7in x (H) 14.6in x (D) 20.7in
WEIGHT	64kg (141lbs)
ACCESSORIES	Touring flying frame Install flying frame Dolly for 4 enclosures Ground stack outrigger Flying Pin

Notes

- (1) Measured on-axis in half (2pi) space at 2 metres, then referred to 1 metre.
- (2) AES Standard ANSI S4.26-1984.
- (3) Measured in half (2pi) space at 2 metres with 1 watt input, using band limited pink noise, then referred to 1 metre.
- (4) Measured in half (2pi) space at 2 metres using band limited pink noise, then referred to 1 metre.
- (5) Measured on-axis in open (4pi) space at 2 metres, then referred to 1 metre.
- (6) Measured in open (4pi) space at 2 metres with 1 watt input, using band limited pink noise, then referred to 1 metre.
- (7) Measured in open (4pi) space at 2 metres using band limited pink noise, then referred to 1 metre.
- (8) Measured in open (4pi) space at 2 metres with 2.83v input, using band limited pink noise, then referred to 1 metre.
- (9) Calculated at 1 metre with 6dB crest factor.
- (10) Measured in half (2pi) space at 2 metres with 2.83V input, using band limited pink noise, then referred to 1 metre.

SXH218

TYPE	Hybrid® horn/reflex subwoofer
FREQUENCY RESPONSE (1)	32Hz – 150Hz ±3dB, -10dB @ 27Hz
DRIVERS	2 x 18" (460mm)/4.5" (115mm) voice coil, long excursion, neodymium magnet, waterproof cone
RATED POWER (2)	3000W AES, 12000W peak
RECOMMENDED AMPLIFIER	iKON iK42
SENSITIVITY (10)	107dB
MAXIMUM SPL(9)	148dB peak (at 1m half space)
NOMINAL IMPEDANCE	4 Ohms
DISPERSION (-6dB)	Omnidirectional/or Cardioid (paired)
ENCLOSURE	Multi-laminate birch/poplar ply
FINISH	Textured Black Polyurea
PROTECTIVE GRILLE	Black perforated steel
CONNECTORS	2 x NL4
PIN CONNECTIONS	Input: +1/-1, refer to input panel for four-core cable link diagram
FITTINGS	Two skids on base, with mating channels on top Four rear-mounted 100mm (4in) castors 6 x bar handles, 3 on each side 4 x fittings for optional transit cover
DIMENSIONS (INCL SKIDS)	(W) 1112mm x (H) 609mm x (D) 1013mm (1140mm incl. castors) (W) 43.8in x (H) 23.9in x (D) 39.9in (44.9in incl. castors)
WEIGHT	116kg (256lbs), with castors 120kg (265lbs)
ACCESSORIES	Transit cover

SXHF218

TYPE	Hybrid® horn/reflex subwoofer
FREQUENCY RESPONSE (1)	32Hz – 150Hz ±3dB, -10dB @ 27Hz
DRIVERS	2 x 18" (460mm)/4.5" (115mm) voice coil, long excursion, neodymium magnet, waterproof cone
RATED POWER (2)	3000W AES, 12000W peak
RECOMMENDED AMPLIFIER	iKON iK42
SENSITIVITY (10)	107dB
MAXIMUM SPL(9)	148dB peak (at 1m half space)
NOMINAL IMPEDANCE	4 Ohms
DISPERSION (-6dB)	Omnidirectional/or Cardioid (paired)
ENCLOSURE	Multi-laminate birch/poplar ply
FINISH	Textured Black Polyurea
PROTECTIVE GRILLE	Black perforated steel
CONNECTORS	2 x NL4
PIN CONNECTIONS	Input: +1/-1, refer to input panel for four-core cable link diagram
FITTINGS	Two skids on base, with mating channels on top Four rear-mounted 100mm (4in) castors 6 x bar handles, 3 on each side 4 x fittings for optional transit cover
DIMENSIONS (INCL SKIDS)	(W) 1152mm x (H) 609mm x (D) 1013mm (1140mm incl. castors) (W) 45.4in x (H) 23.9in x (D) 39.9in (44.9in incl. castors)
WEIGHT	138kg (304lbs), with castors 142kg (313lbs)
ACCESSORIES	Transit cover

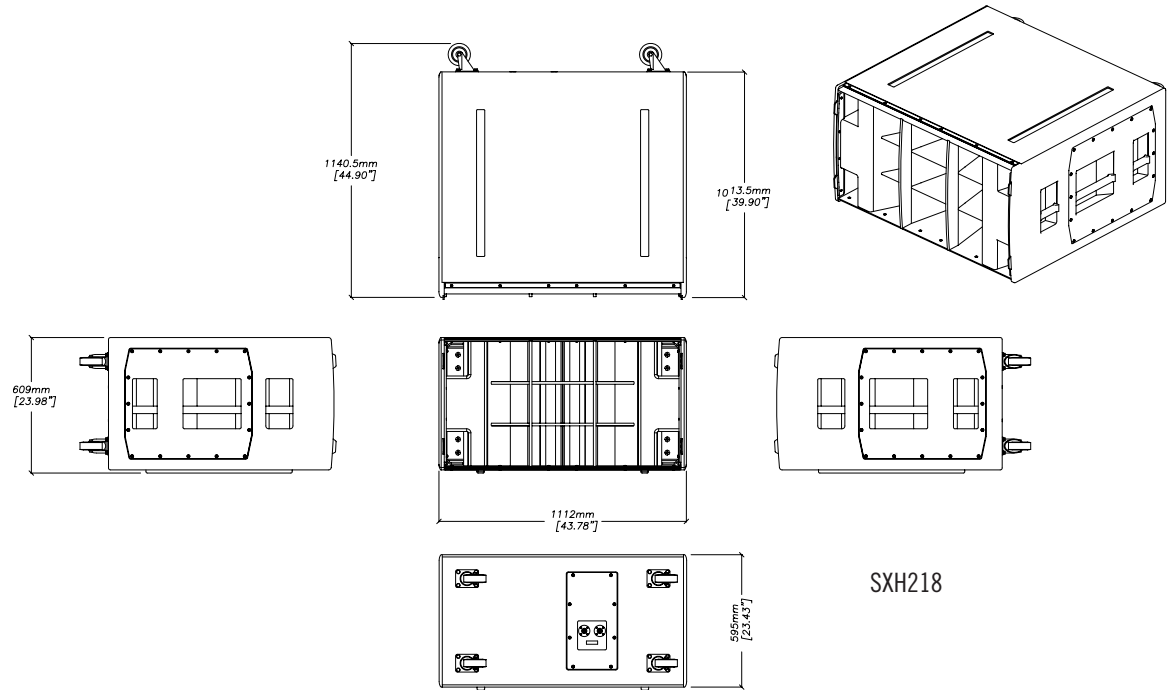

SXH218

iK42

General	
TYPE	Four-channel Class D amplifier
TOTAL OUTPUT POWER	20,000 Watts RMS, all channels driven
DIGITAL SIGNAL PROCESSING	96kHz DSP on all inputs and outputs
COOLING	Dual vari-speed fans, front-to-back airflow
MAXIMUM AMBIENT TEMPERATURE	40°C (104°F)
Audio Inputs/Outputs	
ANALOGUE IN/LINK (4 CHANNELS)	4 x female, 4 x male Neutrik™ XLR
ANALOGUE INPUT IMPEDANCE	20kΩ balanced to ground
MAXIMUM ANALOGUE INPUT LEVEL	+20dBu
NOMINAL SYSTEM GAIN	32dB
AES3 IN/LINK (2 CHANNELS)	1 x female, 1 x male Neutrik™ XLR, balanced
DANTE™ (4 CHANNELS)	2 x shielded RJ45, primary and secondary
AMPLIFIER OUTPUTS	4 x Neutrik Speakon™ NL4
Control and Monitoring Network	
TOPOLOGY	Ethernet
CONTROL APPLICATION	Martin Audio VU-NET™
Power Supply	
TYPE	High performance Series Resonant
AC INPUT OPERATING RANGE	85 – 240V ~ AC, 47 - 63Hz
MAINS INRUSH CURRENT	6A at 115V, 12A at 230V (max for <10ms)
MAINS CONNECTOR	Neutrik 32A Powercon™
Physical	
DIMENSIONS	(W) 483 x (H) 2U/89mm x (D) 357mm (W) 19in x (H) 2U/3.5in x (D) 14.1in incl handles and optional rear support
WEIGHT	12.5kg (27.5lbs)

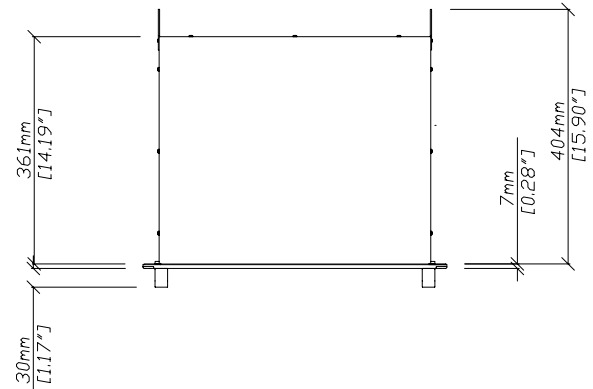

iK42

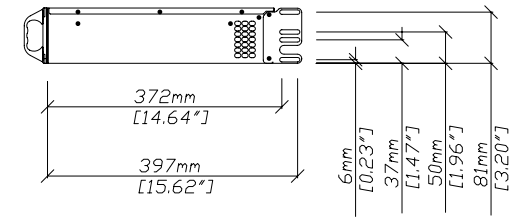
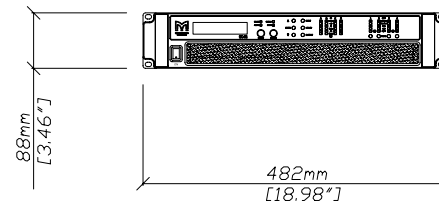

iK81

General	
TYPE	Eight-channel Class D amplifier
TOTAL OUTPUT POWER	10,000 Watts RMS, all channels driven
DIGITAL SIGNAL PROCESSING	96kHz DSP on all inputs and outputs
COOLING	Dual vari-speed fans, front-to-back airflow
MAXIMUM AMBIENT TEMPERATURE	40°C (104°F)
Audio Inputs/Outputs	
ANALOGUE IN/LINK (4 CHANNELS)	4 x female, 4 x male Neutrik™ XLR
ANALOGUE INPUT IMPEDANCE	20kΩ balanced to ground
MAXIMUM ANALOGUE INPUT LEVEL	+20dBu
NOMINAL SYSTEM GAIN	32dB
AES3 IN/LINK (2 CHANNELS)	1 x female, 1 x male Neutrik™ XLR, balanced
DANTE™ (4 CHANNELS)	2 x shielded RJ45, primary and secondary
AMPLIFIER OUTPUTS	4 x Neutrik Speakon™ NL4
Control and Monitoring Network	
TOPOLOGY	Ethernet
CONTROL APPLICATION	Martin Audio VU-NET™
Power Supply	
TYPE	High performance Series Resonant
AC INPUT OPERATING RANGE	85 – 240V ~ AC, 47 - 63Hz
MAINS INRUSH CURRENT	6A at 115V, 12A at 230V (max for <10ms)
MAINS CONNECTOR	Neutrik 32A Powercon™
Physical	
DIMENSIONS	(W) 483 x (H) 2U/89mm x (D) 357mm (W) 19in x (H) 2U/3.5in x (D) 14.1in incl handles and optional rear support
WEIGHT	12.5kg (27.5lbs)

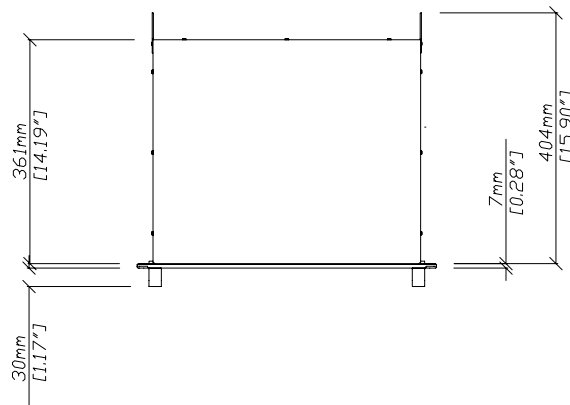

iK81

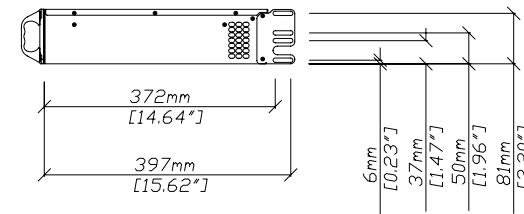
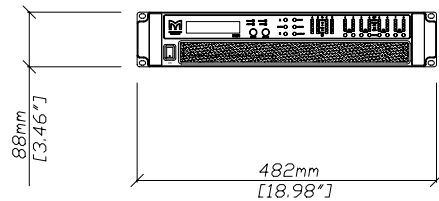

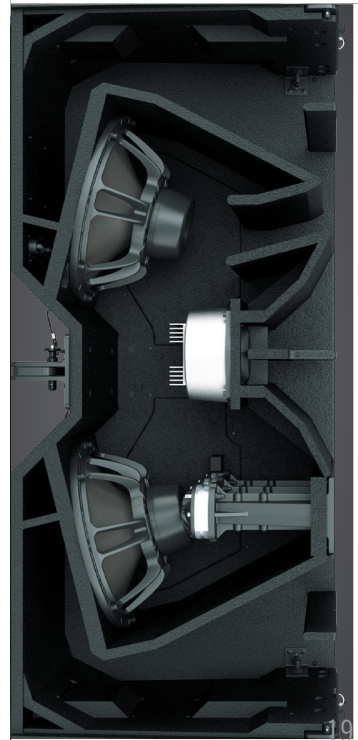



WAVEFRONT PRECISION LONGBOW SCALABLE RESOLUTION GOES FURTHER

Martin Audio Limited

Century Point

Halifax Road

Cressex Business Park

High Wycombe

Buckinghamshire

HP12 3SL

England

FOR SALES ENQUIRIES:

UK

Telephone: +44 (0)1494 535312

E-mail: info@martin-audio.com

NORTH AMERICA

Telephone: 818 649 7776

www.martin-audio.com

All information is Copyright © 2018 Martin Audio Ltd.

Martin Audio, the Martin Audio logo and Hybrid are registered trademarks of Martin Audio Ltd. in the United Kingdom, United States and other countries; all other Martin Audio trademarks are the property of Martin Audio Ltd.



Unite Your Audience
The Martin Audio Experience



Version 1.0